



# CC-Link

Open Field Network

**Cable Wiring Manual**



This documentation describes items to consider in advance, how to select devices, points to keep in mind and procedure in order to set up cable wiring.

Abstract of contents

Chapter 1: Procedure for cable wiring of network system

Chapter 2: Construction and specifications of network system

Chapter 3: Select guide for connected devices

Chapter 4: Set up and cable wiring

We hope that every customer sets up CC-Link system easily by reading this documentation.

If you have any questions about this documentation, please don't hesitate to contact CLPA , which is written on last page of this documentation.

CC-Link Partner Association (CLPA)

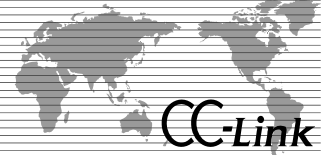

## Contents

Chapter 1: Procedure for cable wiring of network system.....	1
Chapter 2: Construction and specifications of network system.....	3
2.1 Abstract of network construction.....	4
2.2 Network specification.....	5
Chapter 3: Select guide for connected devices.....	13
3.1 CC-Link Cable .....	14
3.2 Terminal resister .....	15
3.3 Connector .....	16
3.4 Power supply .....	17
Chapter 4: Set up and cable wiring.....	19
4.1 Points to keep in mind to set up cable wiring.....	20
4.2 Process and connection of CC-Link dedicated cable (in case of terminal) .....	22
4.3 Connection of terminal resister .....	24
4.4 Shield Connection to ground .....	25



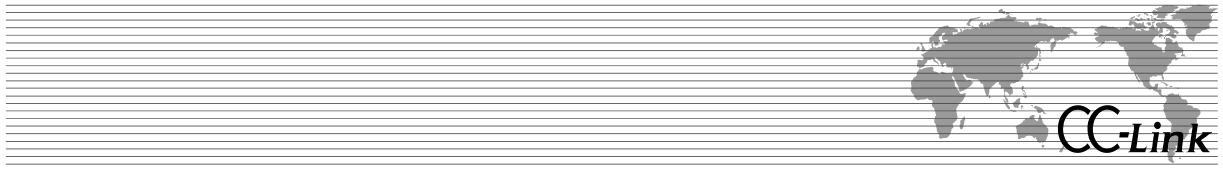

## Chapter 1: Procedure for cable wiring of network system

# CC-Link

## Chapter 1: Procedure for cable wiring of network system

Procedure for cable wiring of CC-Link network system is as following:

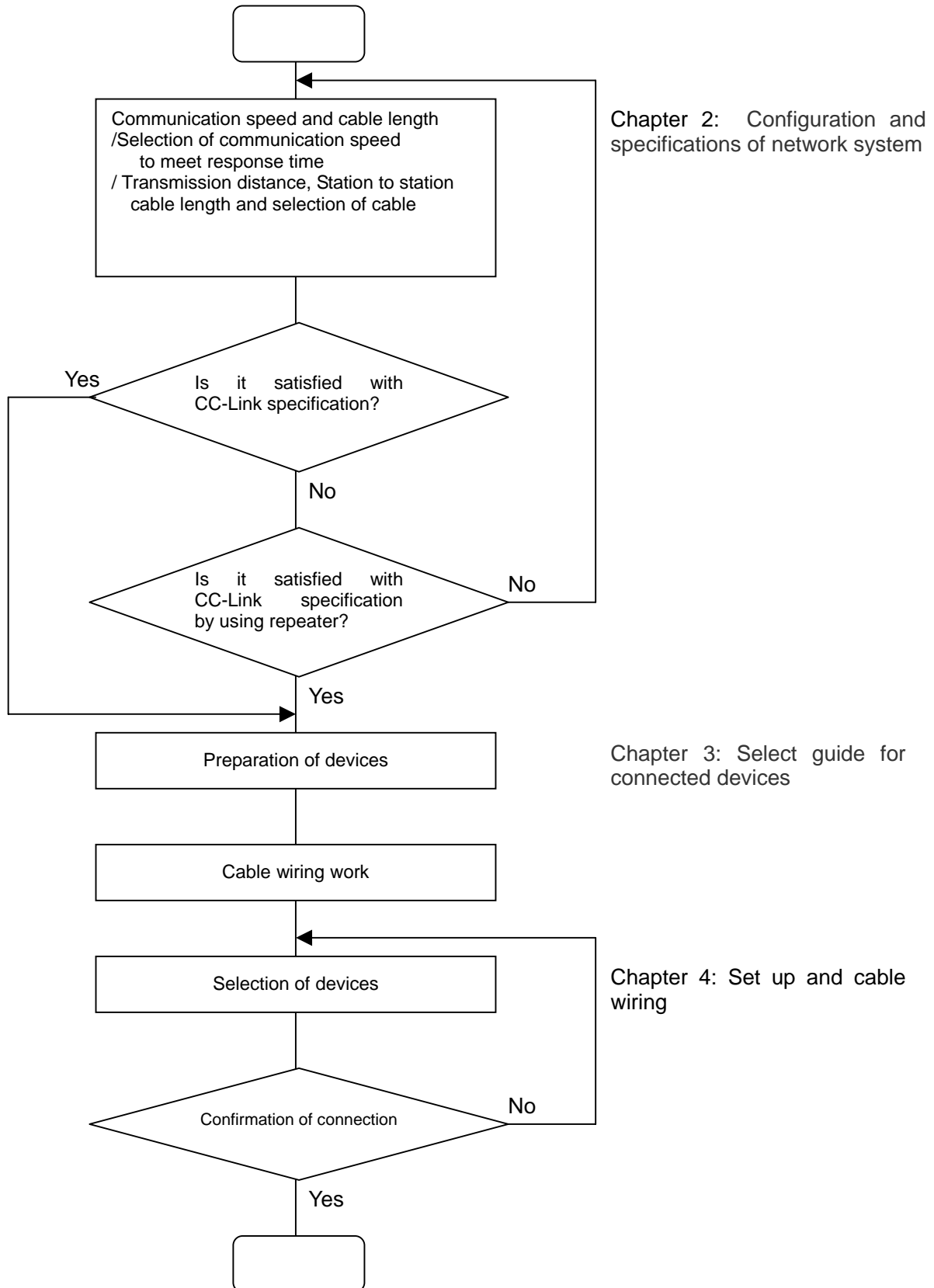
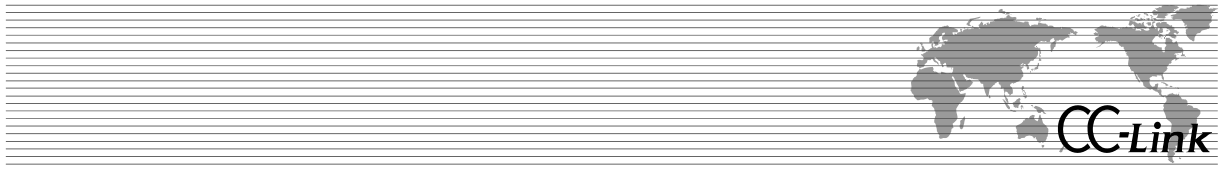

Fig. 1.1 Procedure for cable wiring of CC-Link network system



## Chapter 2: Construction and specifications of network system

# CC-Link

## Chapter 2: Construction and specifications of network system

### 2.1 Abstract of network configuration

Explanation of terminology and definitions of abbreviations

#### **Station:**

A device that is connected via the CC-Link to which any of station numbers 0 to 64 can be assigned.

#### **Master station**

A station that has the control information (parameters) and controls the entire network. One master station is required in each network. The station number is fixed to 0.

#### **Slave station**

A generic station name excluding the master station.

#### **Local station**

A station that can perform n:n cyclic transmission and transient transmission with the master station and other local stations.

#### **Standby master station**

A station that replaces the master station to continue the data link in case the master station function stops. A standby master station has the same functions as those of the master station, and functions as a local station in a normal condition.

#### **Intelligent device station**

A station that can perform 1:n cyclic transmission and transient transmission with the master station.

#### **Remote station**

A generic station name for the remote I/O stations and remote device stations.

#### **Remote device station**

A station that can use bit data and word data.

#### **Remote I/O station**

A station that can only use bit data.

**Cable:** Use CC-Link dedicated cable (Shielded, 3-core twisted pair cable)

**Terminal resister:** The resisters are attached at both edges of cable. The resister reduces reflected wave at terminal point and prevents disturbance of signal. Use resisters suitable for cable used.

**Method to connect:** CC-Link basic connection is multi drop connection. And T-branch connection is available in case of 625Kbps or less of communication speed or in case of using repeater.



## 2.2 Network specification

### (1) Multi-dropped connection

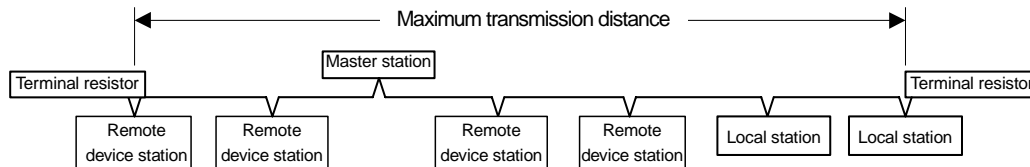

Fig. 2.1 Connection style

**Maximum transmission distance:** Maximum transmission distance means total cable length from edge to edge with multi-dropped connection. The condition of maximum transmission distance depends on communication speed and kinds of CC-Link dedicated cable. Refer to the section “Communication speed and cable length” in Chapter 2 in detail.

Table 2.1 Maximum transmission distance

Communication speed	Maximum transmission distance	
	Ver.1.10 compatible CC-Link dedicated cable Ver.1.00 compatible CC-Link dedicated high-performance cable	Ver.1.00 compatible CC-Link dedicated cable
10Mbps	100m	100m
5Mbps	160m	150m
2.5Mbps	400m	200m
625Kbps	900m	600m
156Kbps	1200m	1200m

**Station to station cable length:** Station to station cable length means cable length between a station and next station. The condition of station to station cable length depends on station type, CC-Link Version and kinds of CC-Link cable. Refer to the section “Communication speed and cable length” in Chapter 2 in detail.

Table 2.2 Station to station cable length

Station type	Station to station cable length	
	Ver.1.10 compatible CC-Link dedicated cable	Ver.1.00 compatible CC-Link dedicated cable Ver.1.00 compatible CC-Link dedicated high-performance cable
Between Master/Local, Intelligent device station and next station	20cm or more	1m or more
Between Remote I/O, Remote device station and Remote I/O, Remote device station	20cm or more	30cm or more

### CC-Link version:

Ver.1.00	
Ver.1.10	The station-to-station cable length increased to 20cm or more, improving wiring performance. *Device and cable specifications changed.
Ver.2.00	System and per-station data volume increased to a maximum of 8 times. <b>*Cable specifications not changed from Ver.1.10.</b>

**Ver.1.10 compatible products:** These products satisfy the CC-Link Ver.1.10 specifications.

They are identified by either of the following indications.

1) "CC-Link" logo mark is attached (Device body, Manual, Catalog, package etc)



2) Version "CC-Link Ver.1.10" is shown. (Manual, name plate, catalog, package, etc.)

We recommend use of the Ver.1.10 compatible cables for the Ver.1.10 or higher (Ver.1.10, Ver.2.0) products.

When the whole system is configured by Ver.1.10 or higher (Ver.1.10, Ver.2.0) products and Ver.1.10 cables, the station-to-station cable length is 20cm or more without exception.

Also, cables of different vendors can be used together.

## Communication speed and cable length:

### 1) Ver.1.10 system

(Condition: All devices and CC-Link cable should be Ver.1.10 compatible products. If any of products is in Ver.1.00, follow the specification for Ver. 1.00)

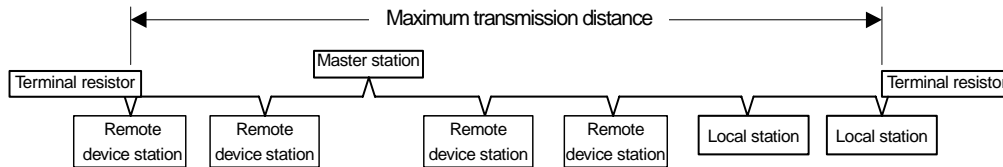

Fig. 2.2 Ver.1.10 system

### CC-Link dedicated cable Ver.1.10(Characteristic Impedance: 110 ohm type)

Table 2.3 Communication speed and cable length (CC-Link dedicated cable Ver.1.10)

Communication speed	156kbps	625kbps	2.5Mbps	5Mbps	10Mbps
Station-to-station cable length	20cm or more	20cm or more	20cm or more	20cm or more	20cm or more
Maximum transmission distance	1200m	900m	400m	160m	100m

### CC-Link dedicated high flexible cable Ver.1.10(Characteristic Impedance: 110 ohm type)

There are the following three different cables according to the specifications of the maximum transmission distance.

- (1) Transmission distance 70% product (the cable model name is ended by "-7".)
- (2) Transmission distance 50% product (the cable model name is ended by "-5".)
- (3) Transmission distance 30% product (the cable model name is ended by "-3".)

Table 2.4 Communication speed and cable length (Ver.1.10 compatible CC-Link dedicated cable for moving parts(Transmission distance 70% product)

Communication speed	156kbps	625kbps	2.5Mbps	5Mbps	10Mbps
Station-to-station cable length	20cm or more	20cm or more	20cm or more	20cm or more	20cm or more
Maximum transmission distance	840m	630m	280m	112m	70m

Table 2.5 Communication speed and cable length (Ver.1.10 compatible CC-Link dedicated cable for moving parts (Transmission distance 50% product)

Communication speed	156kbps	625kbps	2.5Mbps	5Mbps	10Mbps
Station-to-station cable length	20cm or more	20cm or more	20cm or more	20cm or more	20cm or more
Maximum transmission distance	600m	450m	200m	80m	50m



## Chapter 2: Construction and specifications of network system

Table 2.6 Communication speed and cable length (Ver.1.10 compatible CC-Link dedicated cable for moving parts (Transmission distance 30% product))

Communication speed	156kbps	625kbps	2.5Mbps	5Mbps	10Mbps
Station-to-station cable length	20cm or more	20cm or more	20cm or more	20cm or more	20cm or more
Maximum transmission distance	360m	270m	120m	40m	30m

When using CC-Link dedicated cables and cables for moving parts together

Within the following expression range, the Ver.1.10 compatible CC-Link dedicated cables and Ver.1.10 compatible CC-Link dedicated cables for moving parts can be used together.

Maximum transmission distance of CC-Link dedicated cables

$$\geq (\text{CC-Link dedicated cable length}) + (\text{moving parts cable length (transmission distance 70\% product)}) / 0.7 + (\text{moving parts cable length (transmission distance 50\% product)}) / 0.5 + (\text{moving parts cable length (transmission distance 30\% product)}) / 0.3$$

\*Cables of different vendors can be used together if they are Ver.1.10 compatible.

## 2) Ver.1.00 system

(If any of devices or cables is in Ver. 1.00, follow the specification for Ver. 1.00)

<System configured with only Remote I/O station and /or Remote device>

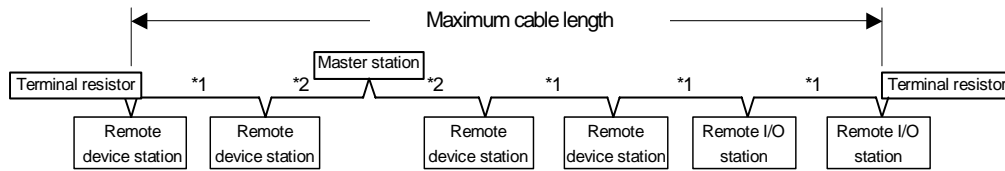

\*1: Cable length between Remote I/O, Remote device and Remote I/O, Remote device.

\*2: Cable length between Master and next station.

Fig. 2.3 In case of system configured with only Remote I/O station and/or Remote device station

<System including Local station and/ or Intelligent device station >

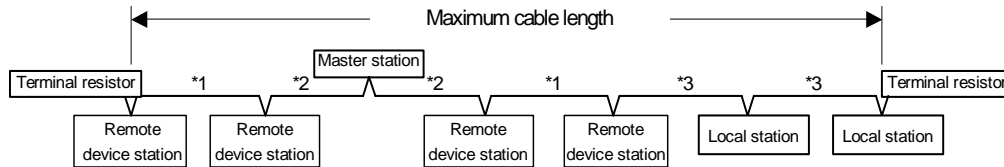

\*1: Cable length between Remote I/O, Remote device and Remote I/O, Remote device.

\*2: Cable length between Master and next station.

\*3: Cable length between Local, Intelligent device and next station.

Fig. 2.4 In case of system including Local and/ or Intelligent device

## Ver.1.00 compatible CC-Link dedicated cable(Characteristic Impedance: 100 ohm type)

Table 2.7 Communication speed and cable length(CC-Link dedicated cable)

Communication speed		156Kbps	625Kbps	2.5Mbps	5Mbps	10Mbps				
Station to station Cable length	Between Master/Local, Intelligent device station and adjacent stations <sup>*2, *3</sup>	1m or more								
	Between Remote I/O, Remote device stations and Remote I/O, Remote device stations(shortest cable) <sup>*1</sup>	30cm or more	30cm or more	30cm or more	60cm or more	30 - 59cm	1m or more	60 - 99cm	30 - 59cm	
Max. transmission distance		1200m	600m	200m	150m	110m	100m	80m	50m	

\*:Upper line includes only Remote I/O, Remote device station. Lower line includes Local, Intelligent device station..

## Ver.1.00 compatible CC-Link dedicated high-performance cable(Characteristic Impedance: 130 ohm type)

Table 2.8 Communication speed and cable length(CC-Link dedicated high performance cable)

Communication speed		156Kbps	625Kbps	2.5Mbps	5Mbps	10Mbps							
Station to station Cable length	Between Master/Local, Intelligent device station and adjacent stations <sup>*2, *3</sup>	1m or more											
	Between Remote I/O, remote device and Remote I/O, remote device(shortest cable) <sup>*1</sup>	30cm or more	30cm or more	30cm or more	60cm or more	30cm or more	1.0m or more	70cm or more	40 - 69cm	30 - 39cm	40cm or more	30 - 39cm	30cm or more
Max. No. of remote stations		64	64	64	64	64				48	32		
Max. transmission distance*		1,200m	900m	400m	-	160m	-	100m	30m	20m	100m	80m	100m
		1,200m	600m	200m	150m	110m	80m	50m	-	-	-	-	-

\*:Upper line includes only Remote I/O, Remote device station. Lower line includes Local, Intelligent device station.

Note:

Only single vendor use in case of Ver.1.00 cable

# Glink

## Chapter 2: Construction and specifications of network system

### (2) T-branch connection

**Trunk line:** The cable attached terminal resistor on both edges.

**Trunk line length:** The cable length of inter terminal resistor without branch line length.

**Branch line:** The cable branched off from trunk line.  
Can not branch off from branch line without repeater.

**Branch line length:** The cable length of 1 branch line.

**Total branch line:** Total length added whole branch line.

### Communication speed and cable length:

#### 1) When repeater is not used

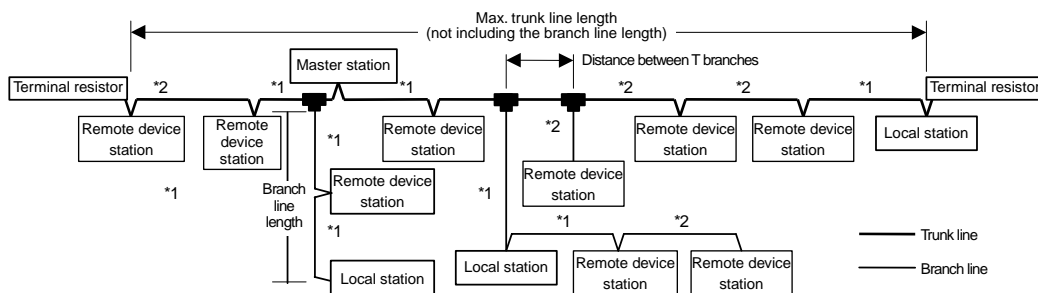

Fig. 2.5 T-branch connection (When repeater is not used)

Table 2.9 Communication speed and cable length (T-branch connection (When repeater is not used))

Communication speed		156kbps	625kbps	10M/5M/2.5Mbps are not allowed
Station-to-station cable length	Between master and local stations, intelligent device station, and adjacent stations *1	1m or more		For a system configured only with remote I/O stations and remote device stations
		2m or more		For a system configuration that contains local stations and intelligent device stations
	Between remote I/O stations and remote device stations (shortest cable) *2	30cm or more		
Max. No. of stations connected to the branch line (per branch)		6		See communication specification for the total number of connected stations
Max. trunk line length		500m	100m	The length of the cable between terminal resistors. The branch line length is not included.
Distance between T branches		No limit		
Max. branch line length		8m		Cable length per branch
Overall branch line length		200m	50m	Total length of all branch lines

Note: As the connection cable, use the Ver.1.10 compatible CC-Link dedicated cable (characteristic impedance 110Ω) or Ver.1.00 compatible CC-Link dedicated cable (characteristic impedance 100Ω).

2) When repeater is used

Enable to Connect T-Branch with repeater at every communication speed.

Enable to Extend transmission distance by using some pcs of repeater.

Note:

When repeater is used, the procedure is not CC-Link specification. Followings are each product specification.

Followings are product repeater specification:

Repeater(T-branch) module

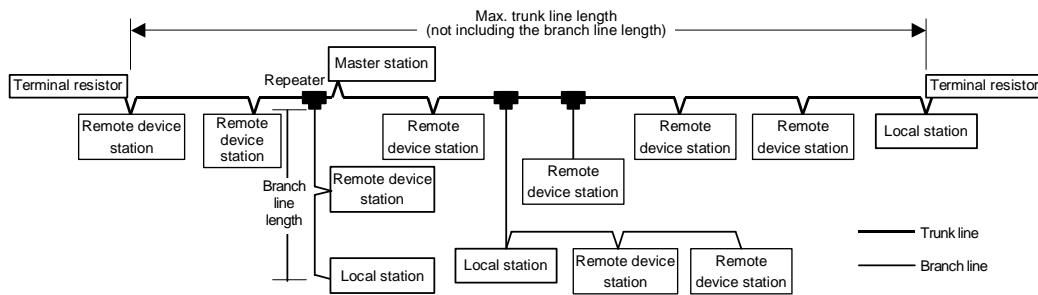

Fig 2.6 T-branch connection (When repeater is used)

Table 2.10 Communication speed and cable length (Repeater (T-branch) module)

Communication speed	156Kbps	625Kbps	2.5Mbps	5Mbps	10Mbps
Station to station cable length	Same as station to station cable length of CC-Link system.				
Max. No. of stations connected to the branch line (Per branch)	No limited (within No. of CC-Link specification)				
Max. trunk line length	Transmission distance of CC-Link system				
Max. branch line length	Transmission distance of CC-Link system				
Max. No. of station per each segment*	10 level				
Total transmission distance (Trunk line length + branch line length)	13200m	9900m	4400m	1760m	1100m

\*:Segment means total name that CC-Link system devices from terminal resistor to resistor on multi drop with using repeater.

# CC-Link

## Chapter 2: Construction and specifications of network system

When optical repeater module is used  
SI/QSI optical fiber cable

Table 2.11 Communication speed and cable length (Optical Repeater module (SI/QSI))

Communication speed	156Kbps	625Kbps	2.5Mbps	5Mbps	10Mbps
Station to station cable length	Same as CC-Link specification				
Max. No. of stations connected to the branch line(per branch)	No limited(within CC-Link specification)				
Max. trunk line length	Transmission distance of CC-Link system				
Max. branch line length	Transmission distance of CC-Link system				
Between repeater max. optical fiber cable length	500m(SI optical fiber cable) 1000m(QSI optical fiber cable)				
Max. No. of stations per segment*	3 level				
Total transmission distance(QSI optical cable)	7800m	6600m	4600m	3640m	3400m

\*: Segment means total name that CC-Link system devices from terminal resistor to terminal resistor on multi drop with using repeater.

GI optical fiber cable

Table 2.12 Communication speed and cable length(Optical repeater module (GI))

Communication speed	156Kbps	625Kbps	2.5Mbps	5Mbps	10Mbps
Station to station cable length	Same as CC-Link specification				
Max. No. of stations connected to the branch line(per branch)	No limited(within CC-Link specification)				
Max. trunk line length	Transmission distance of CC-Link system				
Max. branch line length	Transmission distance of CC-Link system				
Between repeater max. optical fiber cable length	2000m				
Max. No. of stations per segment*	2 level				
Total transmission distance(QSI optical cable)	7600m	6700m	5200m	4480m	4300m

\*:Segment means total name that CC-Link system devices from terminal resistor to terminal resistor on multi drop with using repeater.



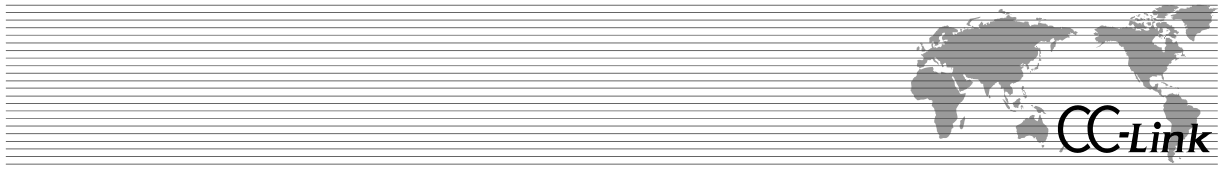

### Chapter 3: Select guide for connected devices

# CC-Link

## Chapter 3: Select guide for connected devices

### 3.1 CC-Link Cable

CC-Link dedicated cable shall be used in CC-Link system.

Specification of CC-Link dedicated cable is as following:

Table 3.1 Specification of CC-Link dedicated cable( Ver.1.10)

Item		Specifications	
Cable type		Shielded twisted cable	
Finish outer diameter		8.0 mm or less	
Number of wire cores		3	
Conductor size		20AWG	
Isolator standard thickness		0.55 to 0.80 mm	
Drain line		20 lines/0.18 mm or 24 lines/0.18 mm Insert separately or in a bundle between the ground cable bundle and aluminum tape.	
Electric characteristics	Conductor resistance (20°C)	37.8Ω/km	
	Insulation resistance	10000 MΩ km or more	
	Withstand voltage	500VDC 1 minute	
	Electrostatic capacity (1kHz)	60 nF/km or less	
	Characteristic impedance	1MHz	110±15Ω
		5MHz	110±6Ω
Attenuation amount (20°C)	1MHz	1.6 dB/100mor less	
	5MHz	3.5 dB/100mor less	
Cross section			

### Connection with device

Table 3.2 The color of isolator and terminal connector

Color of isolator	Terminal
Blue	DA
White	DB
Yellow	DG
Grounding wire(Shield)	SLD

### 3.2 Terminal resistor

The specification of Terminal resistor for CC-Link is as following:

Table 3.3 Specification of terminal resistor

Cable	Terminal resistor
Ver.1.10 compatible CC-Link dedicated cable	110 ohm $\pm$ 5% 1/2W
Ver.1.00 compatible CC-Link dedicated cable	110 ohm $\pm$ 5% 1/2W
Ver.1.00 compatible CC-Link dedicated high-performance cable	130 ohm $\pm$ 5% 1/2W

# CC-Link

## Chapter 3: Select guide for connected devices

### 3.3 Connector

Recommended specifications of connector relaying between CC-Link dedicated cables are as followings:

(1) M12(Micro) type (4 cores)

Table 3.4 Specification of M12(Micro) type (4 cores)

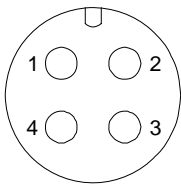
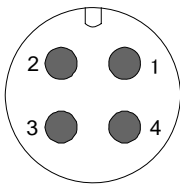
	M12(Micro)type	<u>Contact</u>	
Resistance of conductor	5m ohm or less	CLPA	
Thickness of Gold plate	0.1 micro m or more	Pin position	
Type of water proof	IP67(JIS C 0920)	Female	Male
Pin position	1pin:SLD 2pin:DB 3pin:DG 4pin:DA		

Note: Use Male/Female connector certified by CLPA.  
It can be used for slave station, too. (Limited available product)

(2) Easy connection water proof type(4 cores, 7 cores)

Table 3.5 Easy connection water proof type

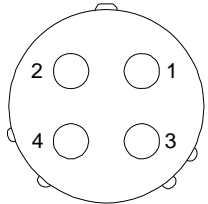
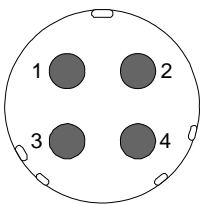
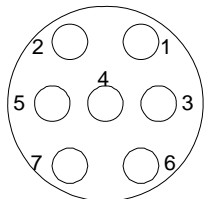
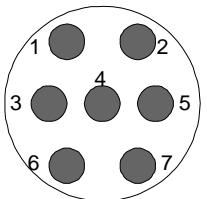
	Easy connection water proof type	<u>Contact</u>	
Contact resistance	5m ohm or less	CLPA	
Thickness of gold plate	0.5 micro m or more		
Type of Water proof	IP67 (JIS C 0920)		
Conducts		Pin position	
4 conductors	1pin:DA 2pin:DB 3pin:DG 4pin:SLD	Female	Male
			
7 conductors (with power conductor)	1pin:DA 2pin:DB 3pin:DG 4pin:N.C. 5pin:+24V 6pin:24G 7pin:SLD	Female	Male
			

Note: It can be used for connection from control panel to out side.

Contact partner vendors which described on CC-Link products catalog published by CLPA or CLPA web site (<http://www.cc-link.org/>)

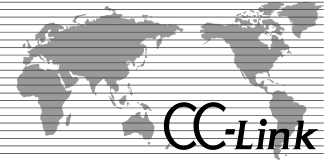

### 3.4 Power supply

Power supply for only communication of CC-Link is not necessary.  
Therefore refer to specification of power supply for each partner vendor.



**Chapter 3: Select guide for connected devices**

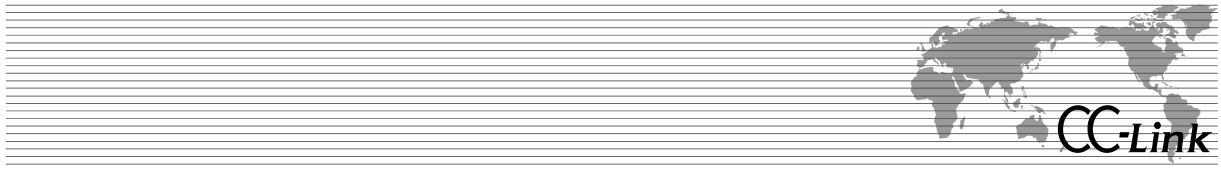

## Chapter 4: Set up and cable wiring

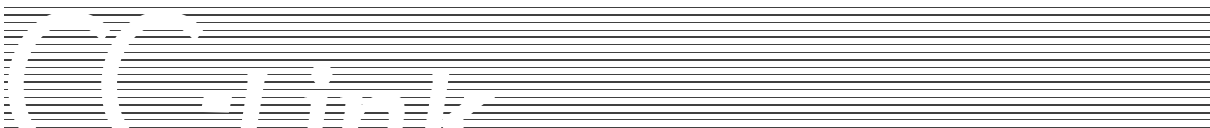

## Chapter 4: Set up and cable wiring

### 4.1 Points to keep in mind to set up cable wiring

/ Communication speed/ Maximum transmission distance

Maximum transmission distance depends on communication speed and/or kinds of CC-Link dedicated cable.

Connect and set up according to Chapter 2 “2.2 Network specification”

#### (1) Minimum radius of bending cable

Keep Minimum radius of bending cable in using CC-Link dedicated cable

It may cause pulling out from connector and cable, breaking of cable , and so on, when CC-Link dedicated cable is used with less than minimum radius.

Minimum radius of bending cable	Connecting	major diameter of cable x 10 or more
	Stable	major diameter of cable x 4 or more

Minimum radius of bending cable at connecting is permitted in only connecting.

Minimum radius of bending cable at stable permits the characteristic for long period.

#### (2) Permissible tension

Do not add tension to cable as much as possible.

If it was pulled strong, it may cause pulling out connector and cable, breaking of cable , possibility of not keeping the characteristic and so on.

At Connecting: If you have no choice but to tension, use within permissible tension.

At Stable: Take notice cable length, how to fix not to add tension to the cable.

Permissible tension(N)=68.6(Unit permissible tension of conductor N/mm<sup>2</sup>)x(No. of cable cores)x(sectional area of conductor)

(Presented by communication cable expert committee of The Japanese Electric Wire & Cable Makers' Association

“Investment Vol. 117 , How to select and use communication cable”

4.2 Section in Chapter 4 Permissible tension of cable (published in April of 1994))



#### Points to keep in mind against noise

In order to prevent induced noise, keep signal line as far away from power line as possible.

(We recommend to wire keeping away 100mm or more)

Not set cable up on control panel where high voltage devices are mounted.

Attach surge absorber on devices which radiate noise.

#### / Others

/ Connect cable during power suppliers of connected devices and communication are in off state.

/ Take care not to twist cable in release cable from drum or wound.

/ Not connect non CC-Link compatible products (lightning arrester, etc) with CC-Link communication line.

It cause reflection wave and/ or attenuation and cannot communicate correctly.

/ keep cable electrically and mechanically as far away from other cable (power cable, etc) as possible,

#### Connection with moving point

Use CC-Link dedicated high flexible cable in case of connecting with moving point.

And take notice the followings in order to prevent cable from being broken early.

/ Not scratch cable coat.

/ Not connect cable with wound.

/ Minimize fixed point to set cable

/ Not to force to fix cable at point where cable moves

/ Connect cable as most suitable length.

/ Secure area for radius of bending cable ten times or more cable outer diameter.

## Chapter 4: Set up and cable wiring

### 4.2 Process and connection of CC-Link dedicated cable (In case of terminal)

Process CC-Link dedicated cable according to the table 4.1. As well, refer to the table 4.1 for the length of removed cable coat, the length of removed signal wire coat and terminal process of signal wire.

Table 4.1 How to process cable

The length of removed cable coat	The length of removed signal wire coat.	Terminal process of signal wire
50mm	3mm	Pressure terminal

#### 1) Removing cable coat

Remove CC-Link dedicated cable coat not to scratch shield mesh. But not remove extra amounts not to cause short.

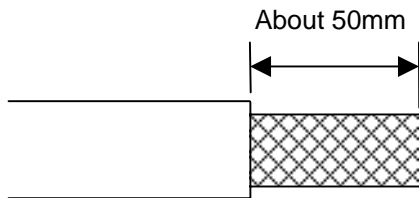

Fig. 4.1 Removed cable coat

#### 2) Process shield

Ravel shield mesh carefully. As well as signal wire, there is one bare drain wire (stranded wire or each wire). Process the shield according to any of followings.

##### (1) When shield mesh is used

Coat with isolation tube after putting tightly shield mesh and drain wire together.

##### (2) When drain wire is used

Coat drain wire with isolation tube after trimming off the excess shield mesh.

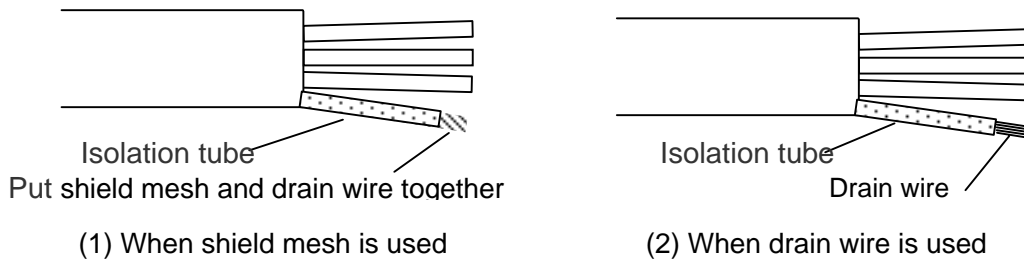

Fig. 4.2 Process shield

### 3) Remove signal wire coat

Remove coat of signal wire according to size of Pressure terminal. Put tightly bear signal wire together.

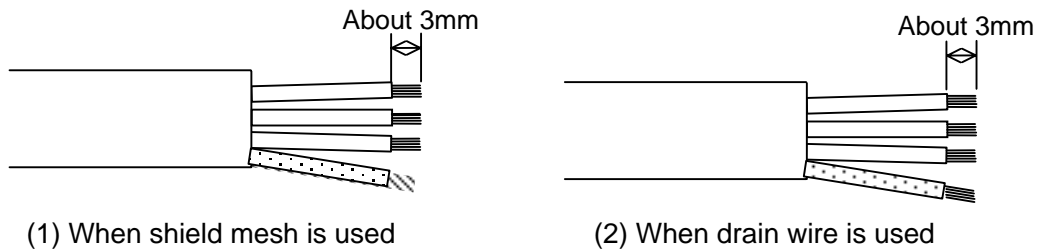

Fig. 4.3 Remove signal wire coat

### 4) Connection pressure terminal

Connect signal wire removed coat, shield wire with pressure terminal differently.

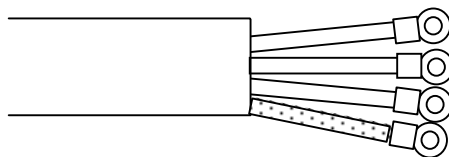

Fig. 4.4 Connection pressure terminal

### 5) Connection terminal

Connect signal wire attached pressure terminal with each terminal then drive a screw in tightly.

Refer to the table 4.2 as to name of terminal and color of cable conductor

Table 4.2 Name of terminal and color of cable conductor

Terminal	Signal conductor
DA	Blue
DB	White
DG	Yellow
SLD	Ground(shield)

# CC-Link

## Chapter 4: Set up and cable wiring

### 4.3 Terminal resistor connection

Connect "terminal resistor" enclosed at both edges.

Table 4.3 Terminal resistor

Terminal resistor (TR)	Cable
110 ohm	Ver.1.10 compatible CC-Link dedicated cable
	Ver.1.00 compatible CC-Link dedicated cable
130 ohm	Ver.1.00 compatible CC-Link dedicated high-performance cable

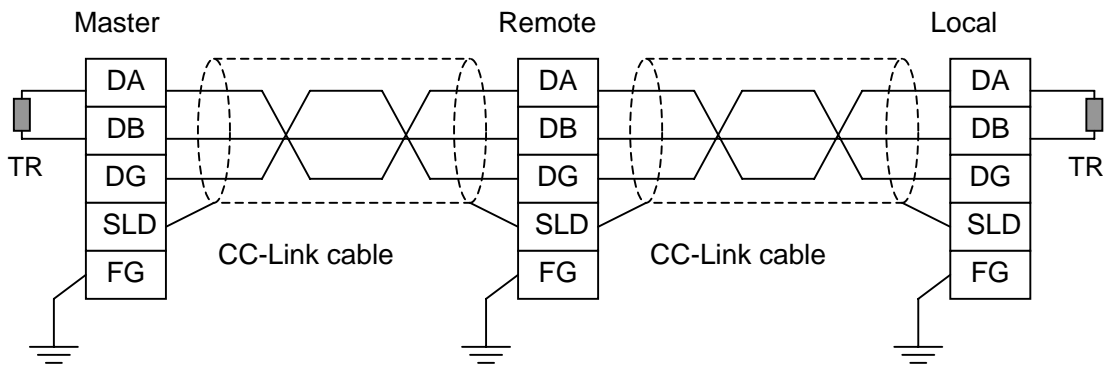

Fig. 4.5 Connection of terminal resistor

#### T-Branch connection

##### (1) When repeater is not used

Connect terminal resistor(110 ohm±5% 1/2W) between DA and DB on each edge of trunk line.

(Not use CC-Link dedicated high performance cable)

##### (2) When repeater is used

Use "Terminal resistor" included in Repeater module.

#### 4.4 Connection of shield line with ground.

- / Connect both edges of shield wire for CC-Link dedicated cable with "SLD" of each module.
- / Connect "FG" of each module independently.
- / Always ground the FG terminals to the protective ground conductor. (Ground resistance: 100 ohm or less)
- / If not use ground independently, use common ground according to the Fig. 4.6.
- / "SLD" and "FG" of each module are connected together inside of the module.
- / Refer to Fig. 4.5 on the previous page for how to connect ground.

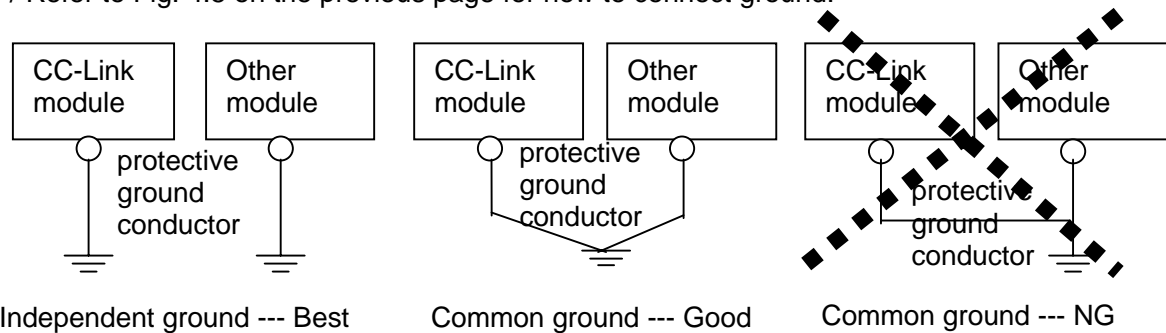

##### 4.4.1 Supplementary explanation on grounding

###### (1) Grounding types

1. Protective grounding to protect human bodies from electric shocks and ground faults
2. Functional grounding to ensure communication reliability

The grounding of the shield wire of the CC-Link dedicated cable is functional grounding to ensure communication reliability.

Indication of protective grounding terminal



Indication of functional grounding terminal



###### (2) Supplements to grounding methods

For protective grounding or functional grounding, use independent grounding (Fig. 4.6) or common grounding where cables are wired individually up to the grounding point (Fig. 4.7).

In the case of common grounding (Fig. 4.8), noise may enter the functional grounding from the protective grounding, making CC-Link communication instable. Especially when common grounding is used for the protective grounding and functional grounding (shield wire of CC-Link dedicated cable) of drive devices such as inverter and servo, the possibility of instable communication will increase.

- 1) As the ground wire of the functional grounding, use a copper wire of 1.6mm or more diameter or 2mm<sup>2</sup> or more.

(As the ground wire up to the grounding point, it is recommended to use the thickest possible copper wire (14mm<sup>2</sup> or more recommended) at a short distance.)

- 2) Do not tie the ground wire of the functional grounding together with the protective grounding wire, power cable, etc. (Noise may enter the ground wire, making communication instable.)

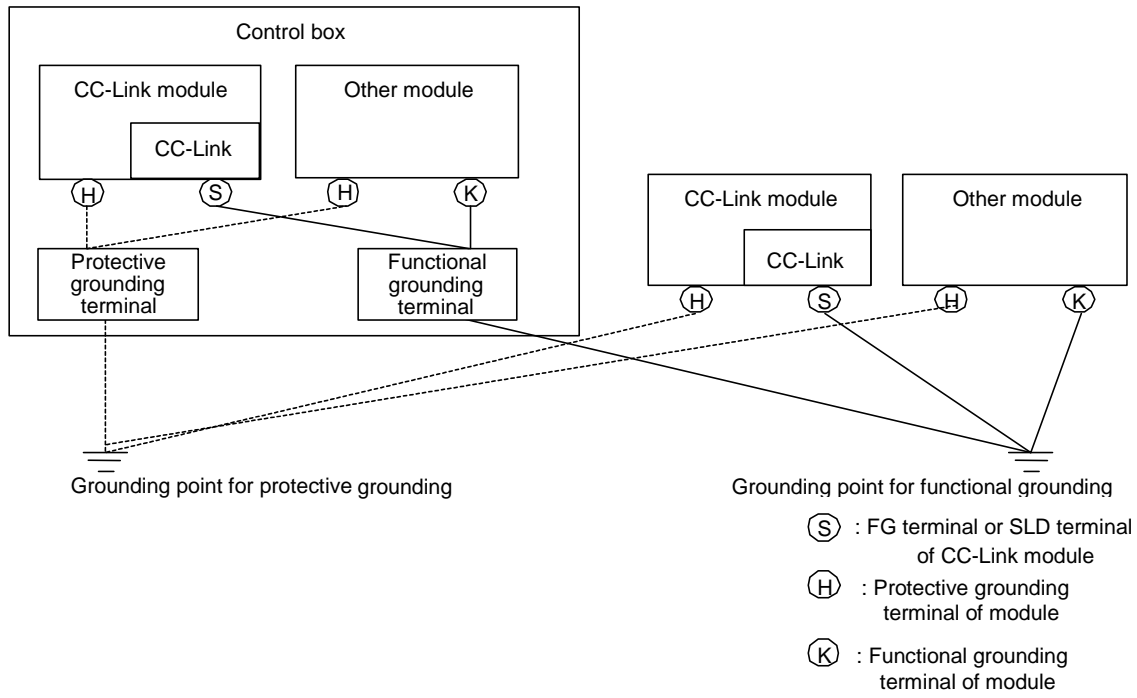

Fig. 4.6 Independent grounding example

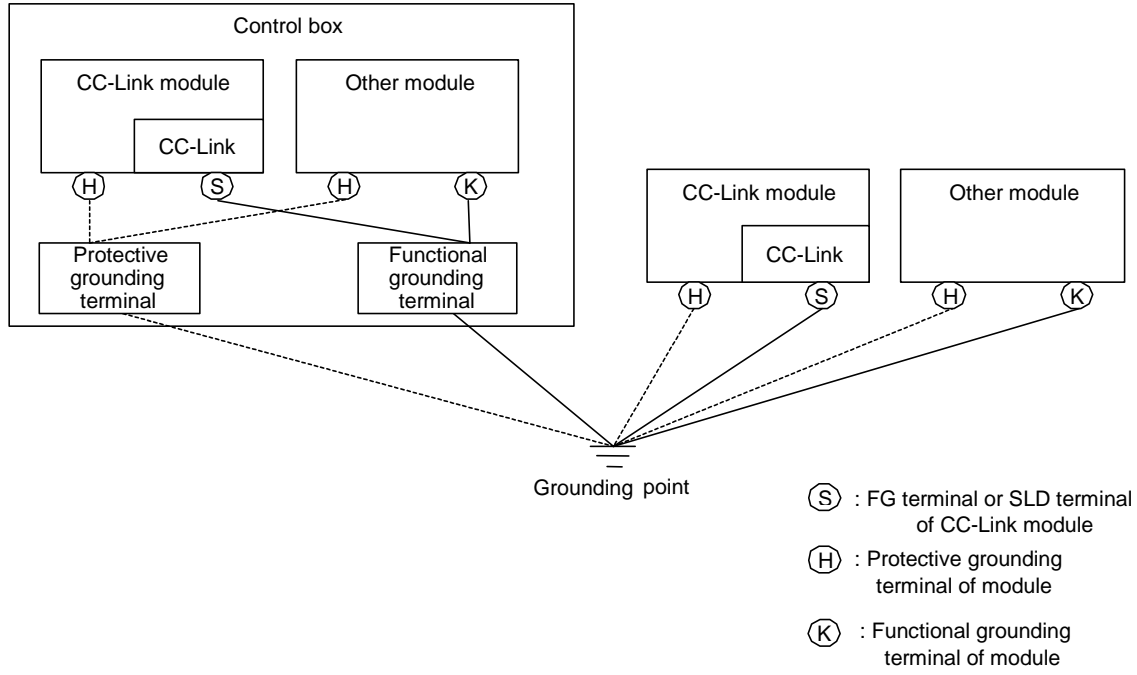

Fig. 4.7 Common grounding example

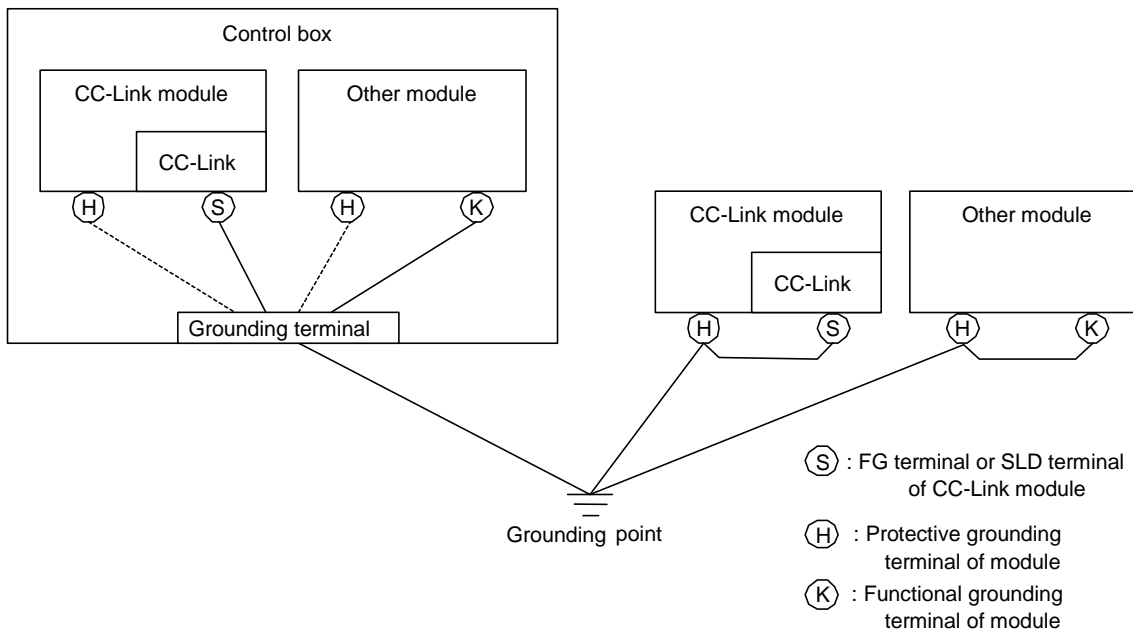
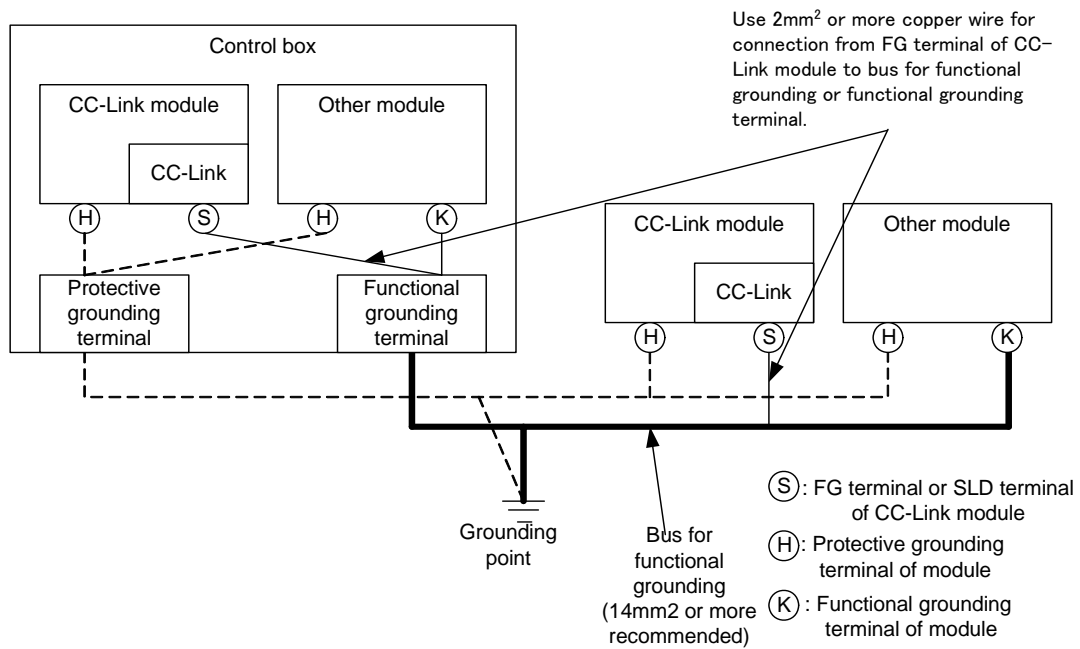
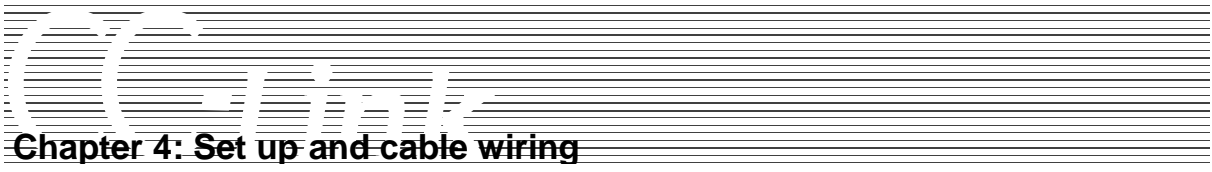

Fig. 4.8 Common grounding example

(3) Wiring example of common grounding

The following shows the wiring example of common grounding.





**Chapter 4: Set up and cable wiring**



Access point

**CC-Link Partner Association (CLPA)**

6F Meiji Yasuda Seimei Ozone Bldg., 3-15-58, Ozone,  
Kita-ku, Nagoya, Aichi 462-0825, Japan

TEL :+81-52-919-1588

FAX :+81-52-916-8655

URL :<http://www.cc-link.org/>

E-Mail :[cc-link@post0.mind.ne.jp](mailto:cc-link@post0.mind.ne.jp)

All rights reserved

